

# OPERATION MANUAL

## PNEUMATIC RIVET NUTS SETTING TOOL

# E-308NP

ESSENTIAL RANGE



EN



FR



PL



CZ



IT



## M3-M8

ALUMINIUM - STEEL - STAINLESS STEEL



■ Scell-it® ■

# GENERAL SAFETY INSTRUCTIONS AND PRINCIPLES



## READ THIS MANUAL CAREFULLY BEFORE USING THE TOOL !

It is **IMPORTANT** to follow the safety instructions for adequate protection against injuries.

- This tool should be used exclusively to apply blind rivet nuts prescribed as **TOOL CAPACITY**. It can't be used for other purposes, such as hammer, etc...
- This tool must be used with treated compressed air supply in a pressure range 0.5MPa-0.7MPa.
- The tool must be, during any kind of maintenance or repair, **DISCONNECTED** from the source of compressed air.
- **DO NOT** use the tool when you are tired or under the influence of drugs, alcohol or medication. One moment of inattention when working with the tool can result in serious injuries.
- **DO NOT** use the tool in the environment described as below:
  - fuel and combustion air.
  - temperature rapidly rising.
  - humidity, rain, water, storm and thundering.
 The tool is not designed for explosive environment.
- When the tool is suspended by the operation hook during use, be sure the tool will not fall.
- When using the tool, always carry safety shoes, protective goggles, protective gloves, safety helmet, ear protectors and other necessary protections. It is highly recommended for safety reason.
- Remove the setting tools or wrenches before switching on the pneumatic tool. A wrench connected to a rotating part of the tool can result in injuries.
- Do not allow persons who have not read these instructions or who are not familiar with the tool to use it.
- Keep children and other persons away when you are working with the tool. If distracted, you may lose control over the tool.
- Have your tool repaired only by qualified specialist personnel and only with original spare parts. If in doubt, always return the tool to the distributor.
- Any alterations of the tool, its accessories or spare parts remain in sole responsibility of the customer.
- The tool must be kept in top condition and regularly tested for damage and proper operation. Check that moving parts function correctly and do not jam and that parts are not broken or damaged in such a way that the function of the tool is impaired. Have damaged parts repaired before using the tool.
- Never aim with the tool at another person.
- Oxygen or other flammable gasses from pressure cylinders must not serve as a driving agent.
- Avoid unnecessary contact with the hydraulic fluid to prevent possible allergy reaction of the skin.
- After the service life, discard the tool according to the applicable disposal.
- The pressure regulator has to be equipped with a filter to avoid impurities and water.

### **TOOL CAPACITY**

blind rivet nuts M3 – M4 – M5 – M6 – M8 all materials and styles

### **TOOL SPECIFICATIONS**

Air supply pressure:	0.5Mpa ~ 0.7Mpa
Output traction power:	14,000 N ~ 19,600 N
Stroke:	1 mm ~ 7 mm adjustable
Net weight :	1.70 kgs

## GETTING START TO WORK

Please refer to the **TOOL EXPLOSIVE ILLUSTRATION** and the **PARTS LIST** in this manual in order to have a good understanding of the tool parts described. The descriptions of the tool parts appear in this manual are in *italics* with the parts position numbers corresponding to the tool explosive illustration.

- 1) This pneumatic powered tool should be worked with compressed air supply. It is recommended to use the air hose with diameter bigger than 8 mm;
- 2) To check the compressed air pressure within the specified range between 0.5Mpa and 0.7Mpa, and to connect the air hose adaptor onto the tool *air adaptor* (#57). The air adaptor has its different versions in different countries and areas, normally the tools are equipped with the correct version as default, in case the air adaptor does not apply in your air supply hose adaptor, contact the tool distributor(s);
- 3) To change and use correct *mandrel* (#1) and *anvil* (#2) according to the size of the rivet nut to be set. This tool is equipped with mandrels and anvils from M3 up to M8 in the tool kit. For convenience, 5 identical *locknuts* (#3) provided in the tool kit for each size of the *mandrel* (#1) and *anvil* (#2) in pairs.

- a) To remove the *anvil* (#2) from the tool and the *locknut* (#3):

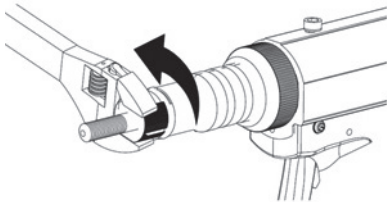

- b) To remove the *knured cover* (#15) and *nose pedestal* (#13):

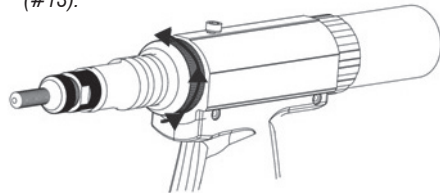

- c) To push back the *sliding sleeve* (#63) meanwhile unscrew out the *mandrel* (#1):

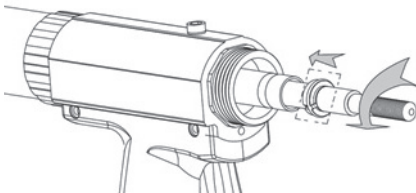

- d) To use the selected mandrel from the tool accessories pack as per rivet nut size, push back the *sliding sleeve* (#63) again and meanwhile screw in the selected mandrel as shown, then release the *sliding sleeve* (#63):

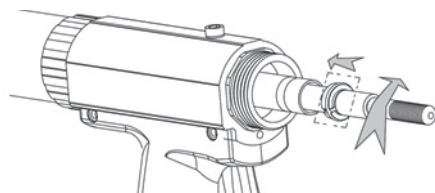

- e) To screw on the *knured cover* (#15) and *nose pedestal* (#13) back to the tool, and *locknut* (#3), and *anvil* (#2):

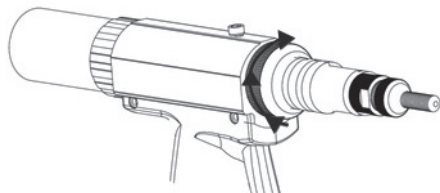

## MANDREL PROTRUDING SET FOR BLIND NUT

FR

PL

CZ

IT

- 1) To set the length of the *mandrel (#1)* protruding out of anvil according to blind rivet nut length, by positioning of the *locknut (#3)*, and *anvil (#2)* screwed on *mandrel (#1)*:

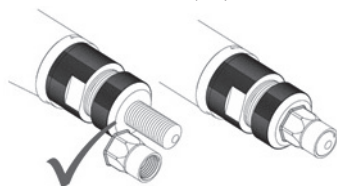

- 2) Never to set the mandrel protruding length too long nor too short according to the rivet nut to be set :

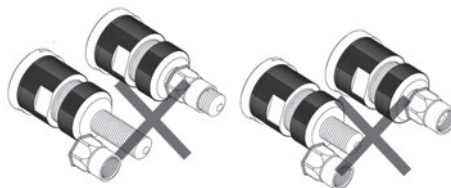

## STROKE SETTING

- 1) Tool stroke should be set according to the workpiece where rivet nut to be set. This tool's stroke can be adjusted between 1 mm and 7 mm.

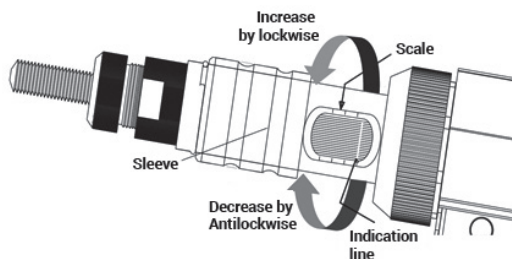

- 2) To set the stroke :

- a) To push the *sleeve (#14)* to the tool mandrel side, as shown :

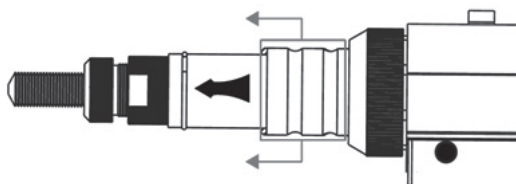

- b) To adjust the tool stroke by turning the knured wheel appearing on tool as shown:

The scales along with the stroke setting window are indications for stroke.

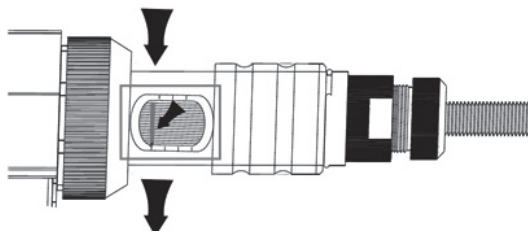

c) To recover the *sleeve* (#14) back to initial position after stroke setting.

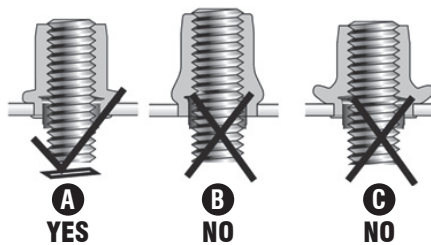

- A** Correctly set
- B** Not fully set
- C** Over-set. Do not pull the nut up too tightly as you may strip the thread in the nut or damage the tool mandrel.

In order to having a precise stroke setting, it is recommended to set a trial rivet nut. In case of the tool's stroke has not been set correctly according to the illustration below, to repeat the operation a) to c) until the stroke has been set correctly.

In case the stroke set too much, or the quality problem of the rivet nut itself, it could be the possibility that the rivet nut can not be released from the tool *mandrel* (#1) after setting. To release the tool from the damaged rivet nut by using a steel wire or equivalent stuff with diameter about 3 mm, inserting into the hole on *nose pedestal* (#13), turn in lock wise to release the rivet nut, as shown :

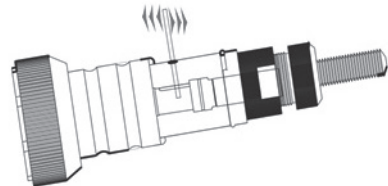

## TOOL OPERATION FOR SETTING RIVET NUTS

- 1) After start-up preparations and stroke setting, to put the rivet nut into workpiece hole (pre-drilled), to insert the tool with *mandrel* (#1) into the rivet nut and push the tool, the *mandrel* (#1) will be turned automatically into the rivet nut;
- 2) To pull the tool *trigger* (#53) to set the rivet nut on its position on workpiece;
- 3) After setting the rivet nut, to release the *trigger* (#53), the *mandrel* (#1) will turn anti-lock wise and the tool released from the set rivet nut. In case the tool still not released from the set rivet nut, to press the button at the back of compressed *spring pedestal* (#27), then the tool will be released.

## OPTIONAL USE OF AIR FLOW ADJUSTOR

The air flow adjustor (in the tool accessories pack) is equipped for changing the air flow released from the tool when the tool is operated. It is nothing to do with the performance of the tool itself but a device for the tool operator's personal preference. Operator might feel uncomfortable when the tool air releasing and blowing his/her arm, and this device can be mounted on the back of the tool, compressed *spring pedestal* (#27), and turning the air release window on this device towards any direction, so the air from the tool will not blow directly to the operator's arm. Meanwhile, through the air release window, the operator still can push the bottom at the back of the compressed *spring pedestal* (#27) to release the tool when necessary (refer to **TOOL OPERATION section 3**).

Please note that the adjustor covering on default loosen and users should use any adhesive tape to tight.

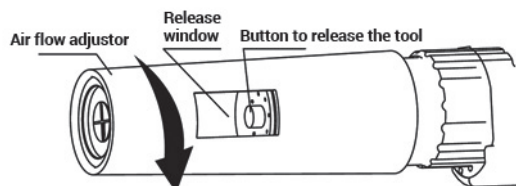

## TOOL MAINTENANCE

If there is no lubricating device connected in the air distribution, **daily and before starting work**, for better performance of the tool, add a few drops of hydraulic oil on the inlet of the *air adaptor* (#57) of the tool in order to reduce the frictions of the tool parts since the oil will be blown inside the tool when tool operates.

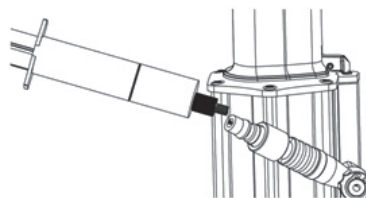

After certain period of use, the tool stroke might be reduced, it shows the hydraulic oil of the pneumatic tool is necessary to be refilled or changed:

- 1) To remove the *screw* (#17) by hexagon wrench :

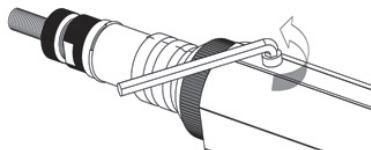

- 2) To connect the air supply and to cover some cloth over the hole where the *screw* (#17) removed, then to pull the *trigger* (#53) and the oil will be leaked out from the tool :

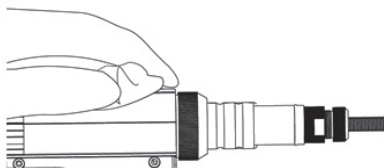

- 3) To screw the oil inject adaptor (on oil injector set in the accessories pack) into the hole where *screw* (#17) removed :

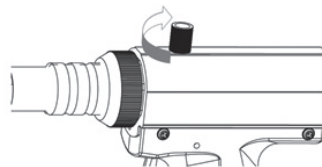

- 4) To use the oil injector (in the accessories pack) to inject the oil slowly until not able to refill, to remove the injector and its adaptor, then clean the oil on the tool and tightly screw on the *screw* (#17) back to the tool :

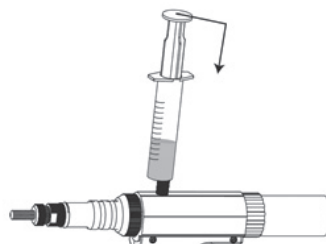

- 5) To test the tool stroke. If the stroke still not enough as it should be, it means there could be some air in the *oil cylinder* (#19) when you refilling the oil to the tool. Then the extra air needs to be released from the tool.

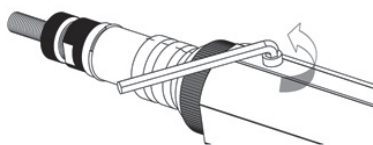

To connect the tool with air supply, to pull the tool *trigger* (#53) 6 or 7 times, then loosen the *screw* (#17), let the extra air leaking out, then screw on the *screw* (#17) tight again:

# TOOL EXPLOSIVE ILLUSTRATION

EN

FR

PL

CZ

IT

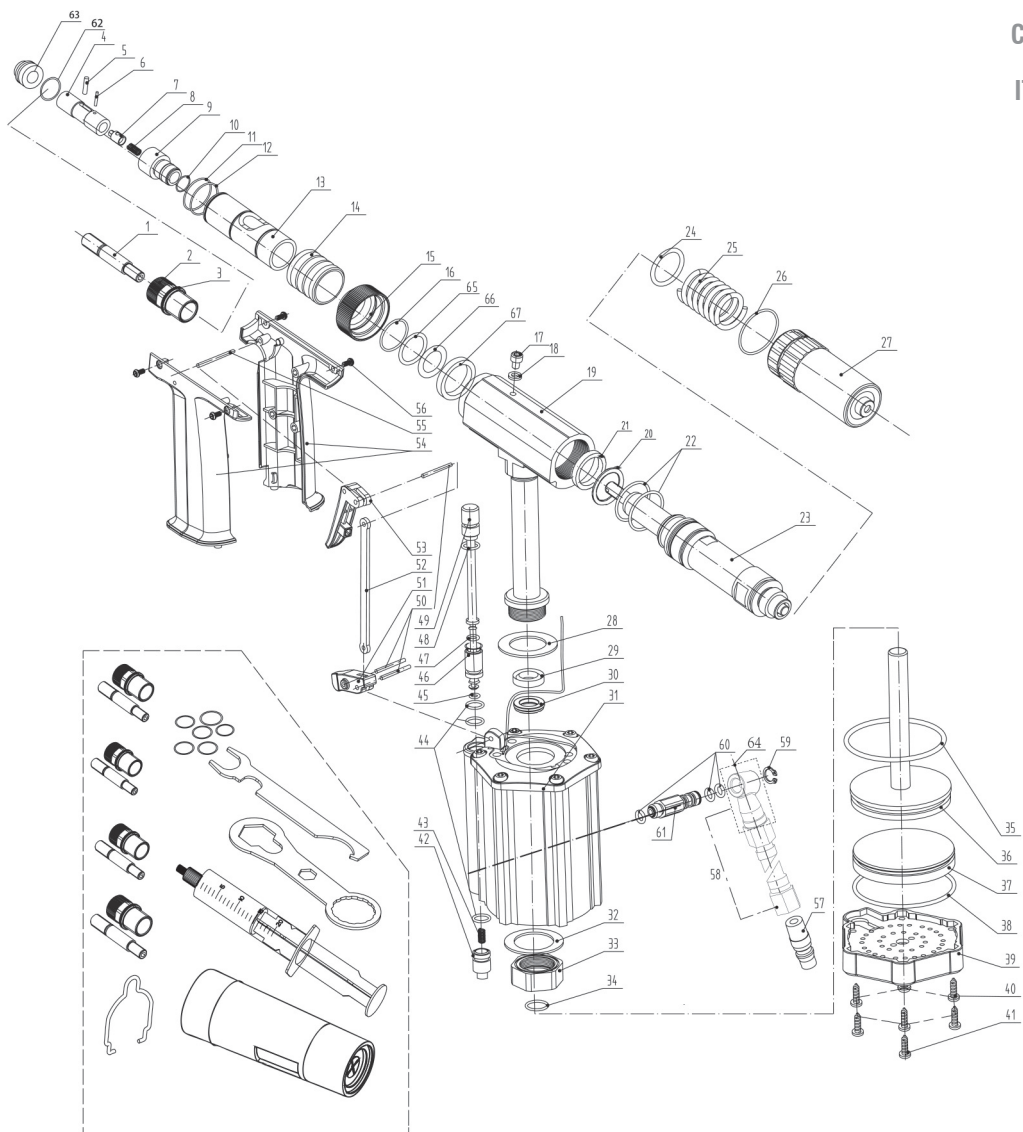

EN

## WARRANTY CONDITIONS

FR

During the warranty period, the customer must not perform any alterations other than those permitted by the manufacturer (maintenance). The repairs must be done by an authorized service center.

PL

To admit warranty repair, the customer must return the defective tool to the service center of the manufacturer with the proof of purchase. Warranty is valid only if the tool is in its warranty period (12 months from the date of purchase confirmed by the proof of purchase) and if the conditions of use have been respected.

CZ

Warranty is not valid if worn spare parts have to be replaced (further to a normal use of the tool).

IT

### EC CERTIFICATE OF CONFORMITY – EC DIRECTIVE 2006/42/EC ANNEX II 1A

The manufacturer :

**SCCELL-IT**  
**28 RUE PAUL DUBRULE**  
**59810 LESQUIN**  
**FRANCE**  
**Tél.: +33(0) 320 329 818**

Declares hereby that the following product :

**Manual pneumatic hydraulic rivet nuts setting tool type E-308NP**

Complies with the following relevant conditions :

**EC Machinery Directive 2006/42/EC Annex I**

If the machine is modified without our knowledge and consent, this EC Declaration of conformity will be voided

Most important applied harmonized standards :

**EN ISO12100:2010 + EN ISO11148-1:2011**

Name of documentation officer : Nadia FAYTRE

Address of documentation officer : see address of manufacturer

Lesquin, 30/07/2019

\_\_\_\_\_  
Franck DEBRUYNE

(Directeur général)





# CONSIGNES GÉNÉRALES DE SÉCURITÉ ET PRINCIPES



## CE MANUEL D'UTILISATION DOIT ÊTRE LU ATTENTIVEMENT AVANT TOUTE UTILISATION DE LA MACHINE !

Il est **IMPORTANT** de suivre les instructions de sécurité pour une bonne utilisation de la machine sans prise de risque :

- Cette machine ne doit être utilisée que pour sertir des écrous qui correspondent à la **CAPACITÉ DE LA MACHINE**. Elle ne peut pas être utilisée dans un autre but (marteau etc...).
- Cette machine doit être utilisée avec une alimentation en air comprimé dans une plage de pression 0,5Mpa ~ 0,7Mpa.
- **DECONNECTER** l'alimentation en air comprimé de la machine avant le remplacement d'une pièce ou pendant une réparation.
- **NE PAS** utiliser la machine en cas de fatigue, ou sous l'influence de substances telles que les drogues, l'alcool ou encore les médicaments.
- **NE PAS** utiliser la machine dans un environnement tel que décrit ci-dessous :
  - Carburant et air de combustion.
  - Hausse rapide de température.
  - Humidité, pluie, tempête et orage.
 Cette machine n'est pas adaptée aux environnements explosifs.
- Quand la machine est suspendue par le crochet d'opération pendant l'utilisation, s'assurer qu'elle ne puisse pas tomber.
- N'utiliser la machine que sur des supports pré-perçés pour écrous à sertir.
- Le port de lunettes protectrices est obligatoire. Il est recommandé de porter des chaussures de sécurité, des vêtements adaptés, des gants, un casque de sécurité, des protections auditives et toutes autres protections nécessaires.
- Ne pas porter de vêtements amples ni de bijoux. Et veiller à garder les cheveux, vêtements et gants à l'écart des pièces en mouvement. Les vêtements amples, les bijoux ou les cheveux longs pourraient s'emmêler dans les pièces en mouvement.
- Retirer les éventuels accessoires ou clés de réglage avant de mettre la machine en marche. Une clé montée sur une pièce rotative de l'outil peut entraîner des blessures.
- Ne pas laisser les personnes non familiarisées ou expérimentées utiliser la machine.
- Tenir les enfants et toutes autres personnes à l'écart pendant l'utilisation de la machine. Un moment d'inattention peut vous faire perdre le contrôle de la machine.
- Toute modification de l'outil, de ses accessoires ou de ses pièces de rechange reste sous la seule responsabilité du client.
- N'utiliser que les pièces de rechange vendues par le fabricant.
- Les réparations doivent être effectuées par une personne habilitée. En cas de doute, toujours retourner l'outil au distributeur.
- L'outil doit être entretenu correctement et il doit être régulièrement testé pour vérifier son bon fonctionnement. Vérifier que les pièces mobiles ne bloquent pas le système. Vérifier également qu'aucune pièce ne soit cassée ou endommagée, cela pourrait altérer le fonctionnement de l'outil. Toujours faire réparer les pièces endommagées avant d'utiliser l'outil.
- Ne jamais diriger la machine vers soi, vers une autre personne ou vers un animal.
- L'oxygène ou d'autres gaz inflammables provenant de bouteilles à pression ne doivent pas servir d'agent d'entraînement.
- Éviter tout contact inutile avec le fluide hydraulique afin d'éviter toute réaction allergique de la peau.
- A la fin de sa durée de vie, jeter l'outil dans un endroit adapté afin que les pièces puissent être recyclées.
- Le régulateur de pression doit être équipé d'un filtre pour éviter les impuretés et l'eau.

### **CAPACITÉ DE LA MACHINE**

Écrous à sertir M3 – M4 – M5 – M6 – M8 tous matériaux

### **CARACTERISTIQUES DE LA MACHINE**

Pression circuit d'air comprimé :	5 bar ~ 7 bar
Force :	14 000 N ~ 19 600 N
Course :	1 mm ~ 7 mm ajustable
Poids net :	1,70 kg